

# G 30x40x4

## Dimensions

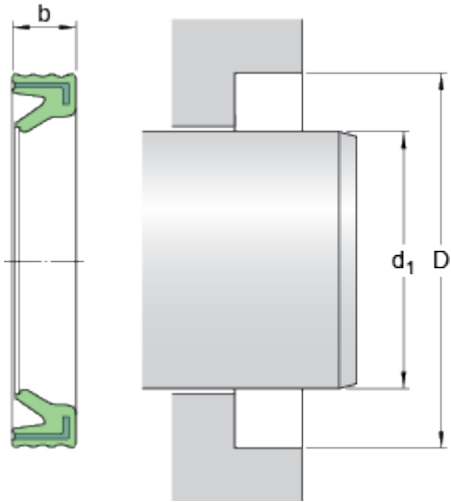

$d_1$	30	mm
$D$	40	mm
$b$	4	mm

## Application and operating conditions

Operating temperature	min.	-30	°C
Operating temperature	max.	110	°C
Shaft surface speed	max.	10	m/s