

G 24x32x4

Dimensions

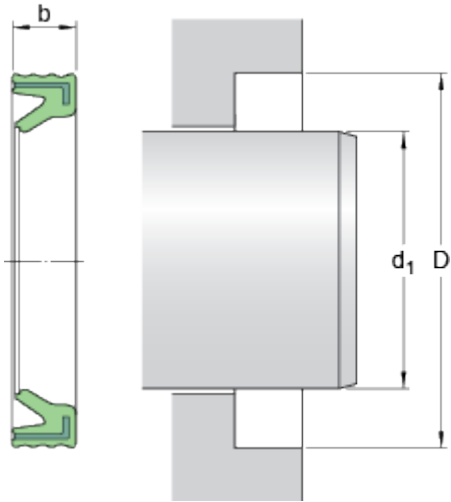

d_1	24	mm
D	32	mm
b	4	mm

Application and operating conditions

Operating temperature	min.	-30	°C
Operating temperature	max.	110	°C
Shaft surface speed	max.	10	m/s