

G 20x28x4

Dimensions

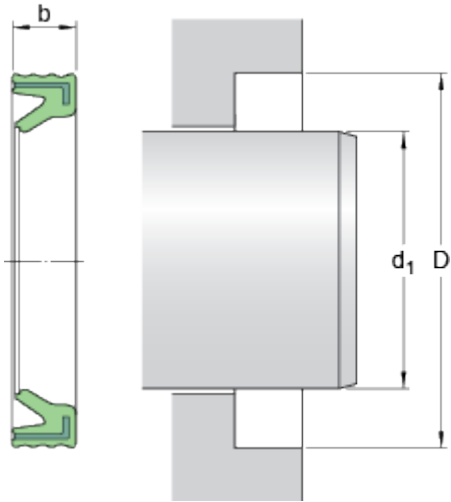

d_1	20	mm
D	28	mm
b	4	mm

Application and operating conditions

Operating temperature	min.	-30	°C
Operating temperature	max.	110	°C
Shaft surface speed	max.	10	m/s