

# G 20x26x4

## Dimensions

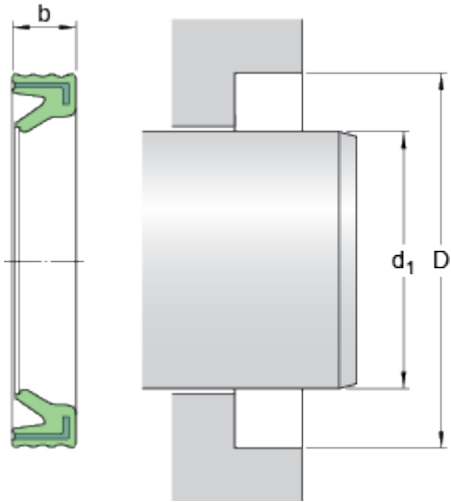

$d_1$	20	mm
$D$	26	mm
$b$	4	mm

## Application and operating conditions

Operating temperature	min.	-30	°C
Operating temperature	max.	110	°C
Shaft surface speed	max.	10	m/s