

G 18x26x4

Dimensions

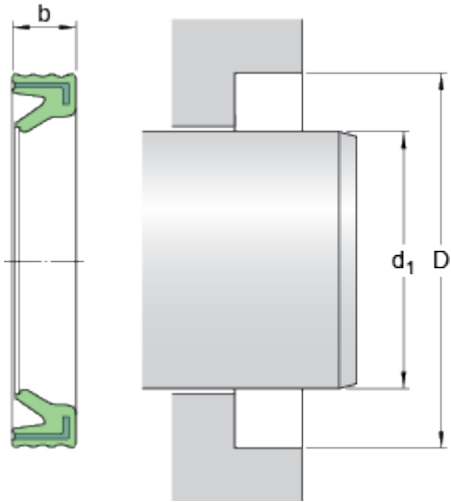

d_1	18	mm
D	26	mm
b	4	mm

Application and operating conditions

Operating temperature	min.	-30	°C
Operating temperature	max.	110	°C
Shaft surface speed	max.	10	m/s