

# G 17x25x3

## Dimensions

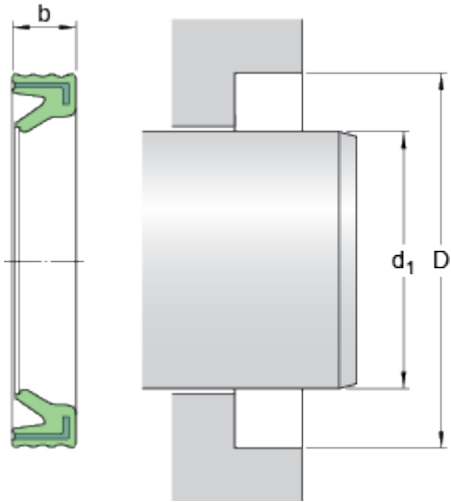

$d_1$	17	mm
D	25	mm
b	3	mm

## Application and operating conditions

Operating temperature	min.	-30	°C
Operating temperature	max.	110	°C
Shaft surface speed	max.	10	m/s