

G 16x24x3

Dimensions

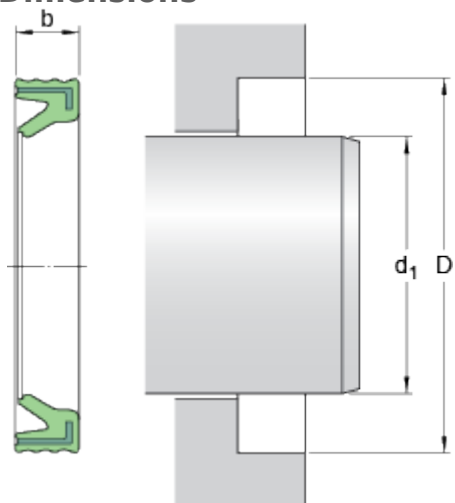

d_1	16	mm
D	24	mm
b	3	mm

Application and operating conditions

Operating temperature	min.	-30	°C
Operating temperature	max.	110	°C
Shaft surface speed	max.	10	m/s