

8620

Dimensions

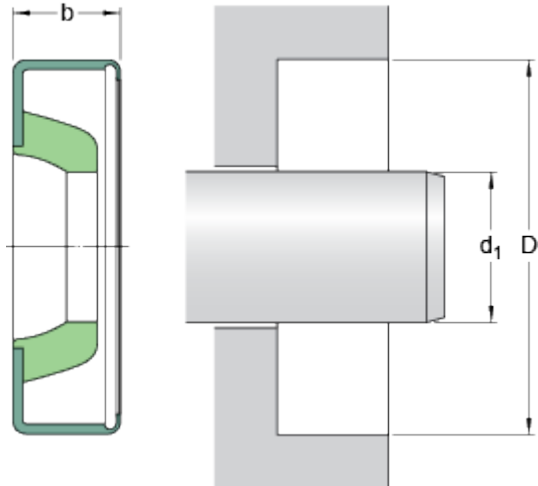

d_1	22.225	mm
D	28.58	mm
b	3.18	mm

Application and operating conditions

Pressure differential	max.	0.07	MPa
Operating temperature	min.	-40	°C
Operating temperature	max.	100	°C
Operating temperature, short period	max.	120	°C
Rotational speed	max.	8593	r/min
Shaft surface speed	max.	10	m/s