

6300-2RSH

SKF Explorer

Dimensions

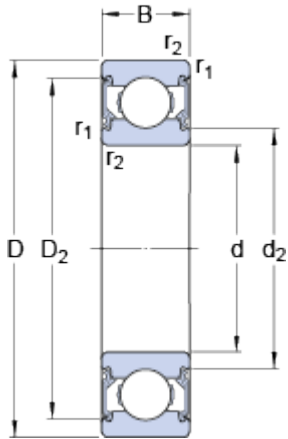

d		10	mm
D		35	mm
B		11	mm
d ₂	≈	15.5	mm
D ₂	≈	28.68	mm
r _{1,2}	min.	0.6	mm

Abutment dimensions

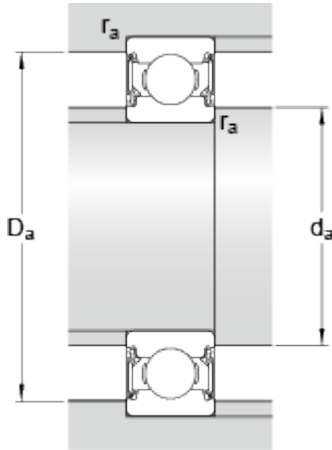

d _a	min.	14.2	mm
d _a	max.	15.5	mm
D _a	max.	30.8	mm
r _a	max.	0.6	mm

Calculation data

Basic dynamic load rating	C	8.52	kN
Basic static load rating	C	3.4	kN
Fatigue load limit	P _u	0.143	kN
Limiting speed		15000	r/min
Calculation factor	k _r	0.03	
Calculation factor	f	11	

Mass

Mass bearing		0.054	kg
--------------	--	-------	----