

# 627-2Z

SKF Explorer

## Dimensions

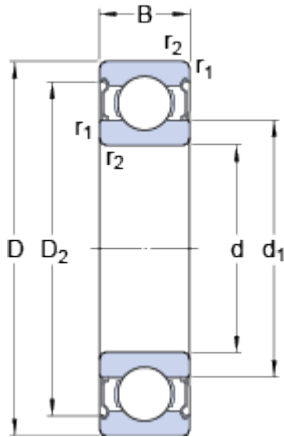

d	7	mm
D	22	mm
B	7	mm
d <sub>1</sub>	≈ 12.15	mm
D <sub>2</sub>	≈ 19.2	mm

## Abutment dimensions

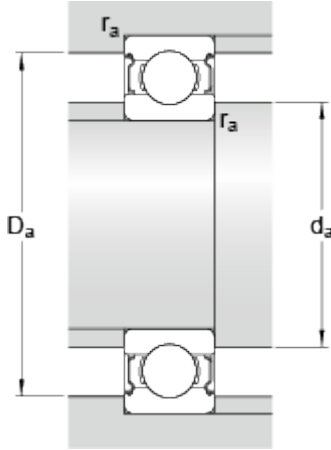

d <sub>a</sub>	min.	9.4	mm
d <sub>a</sub>	max.	12.1	mm
D <sub>a</sub>	max.	19.6	mm
r <sub>a</sub>	max.	0.3	mm

## Calculation data

Basic dynamic load rating	C	3.45	kN
Basic static load rating	C	1.37	kN
Fatigue load limit	P <sub>u</sub>	0.057	kN
Reference speed		70000	r/min
Limiting speed		36000	r/min
Calculation factor	k <sub>r</sub>	0.025	
Calculation factor	f	12	

## Mass

Mass bearing		0.013	kg
--------------	--	-------	----