

623-2Z

Dimensions

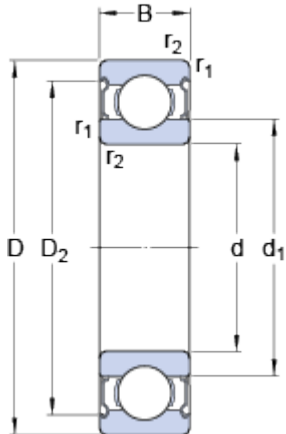

d		3	mm
D		10	mm
B		4	mm
d ₁	≈	5.2	mm
D ₂	≈	8.2	mm
r _{1,2}	min.	0.15	mm

Abutment dimensions

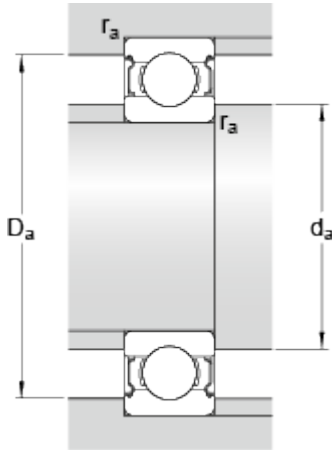

d _a	min.	4.2	mm
d _a	max.	5.1	mm
D _a	max.	8.8	mm
r _a	max.	0.1	mm

Calculation data

Basic dynamic load rating	C	0.54	kN
Basic static load rating	C	0.18	kN
Fatigue load limit	P _u	0.007	kN
Reference speed		130000	r/min
Limiting speed		60000	r/min
Calculation factor	k _r	0.025	
Calculation factor	f	7.5	

Mass

Mass bearing		0.0015	kg
--------------	--	--------	----