

# 62208-2RS1

## Dimensions

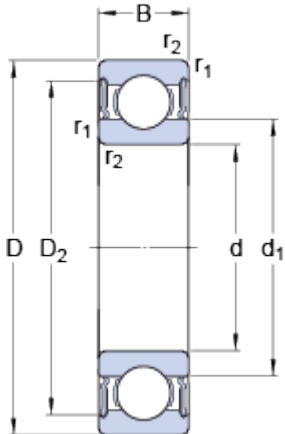

d		40	mm
D		80	mm
B		23	mm
d <sub>1</sub>	≈	52.6	mm
D <sub>2</sub>	≈	69.8	mm
r <sub>1,2</sub>	min.	1.1	mm

## Abutment dimensions

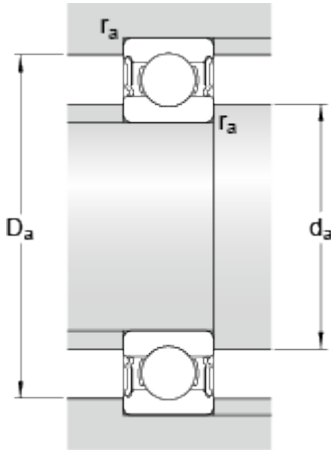

d <sub>a</sub>	min.	47	mm
d <sub>a</sub>	max.	52.5	mm
D <sub>a</sub>	max.	73	mm
r <sub>a</sub>	max.	1	mm

## Calculation data

Basic dynamic load rating	C	30.7	kN
Basic static load rating	C	19	kN
Fatigue load limit	P <sub>u</sub>	0.8	kN
Limiting speed		5600	r/min
Calculation factor	k <sub>r</sub>	0.025	
Calculation factor	f	13.8	

## Mass

Mass bearing		0.47	kg
--------------	--	------	----