

6205-2RSH

SKF Explorer

Dimensions

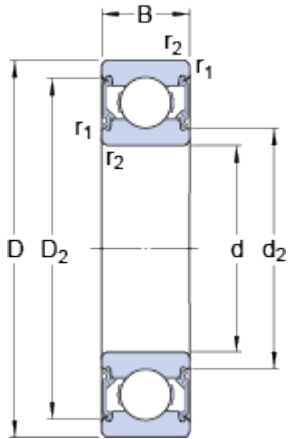

d		25	mm
D		52	mm
B		15	mm
d ₂	≈	31.3	mm
D ₂	≈	46.21	mm
r _{1,2}	min.	1	mm

Abutment dimensions

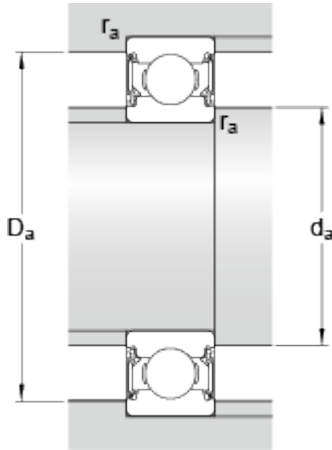

d _a	min.	30.6	mm
d _a	max.	31.5	mm
D _a	max.	46.4	mm
r _a	max.	1	mm

Calculation data

Basic dynamic load rating	C	14.8	kN
Basic static load rating	C	7.8	kN
Fatigue load limit	P _u	0.335	kN
Limiting speed		8500	r/min
Calculation factor	k _r	0.025	
Calculation factor	f	14	

Mass

Mass bearing		0.13	kg
--------------	--	------	----