

6204-2ZNR

SKF Explorer

Dimensions

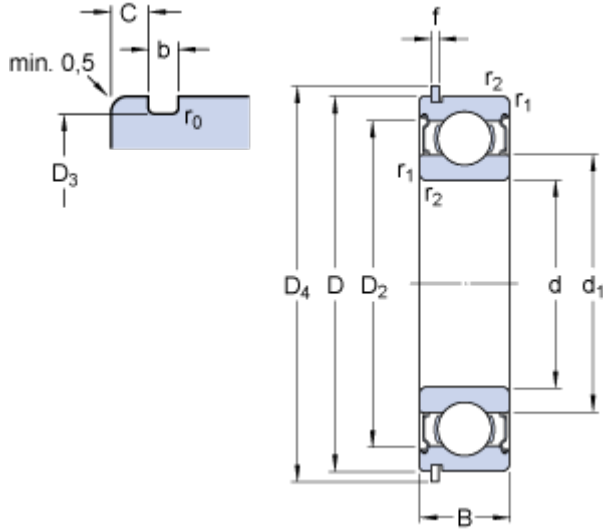

d		20	mm
D		47	mm
B		14	mm
d ₁	≈	28.8	mm
D ₂	≈	40.59	mm
D ₃		44.6	mm
D ₄		52.7	mm
b		1.35	mm
C		2.46	mm
f		1.12	mm
r	max.	0.4	mm
r _{1,2}	min.	1	mm

Abutment dimensions

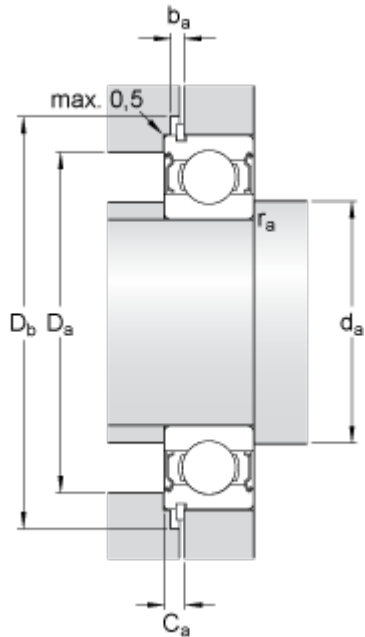

d _a	min.	25.6	mm
d _a	max.	28.7	mm
D _a	max.	41.4	mm
D _b	min.	54	mm
b _a	min.	1.5	mm
C _a	max.	3.58	mm
r _a	max.	1	mm

Calculation data

Basic dynamic load rating	C	13.5	kN
Basic static load rating	C	6.55	kN
Fatigue load limit	P _u	0.28	kN
Reference speed		32000	r/min
Limiting speed		17000	r/min
Calculation factor	k _r	0.025	
Calculation factor	f	13	

Mass

Mass bearing		0.11	kg
--------------	--	------	----

Included products

Snap ring

SP 47