

6202-2RSH

SKF Explorer

Dimensions

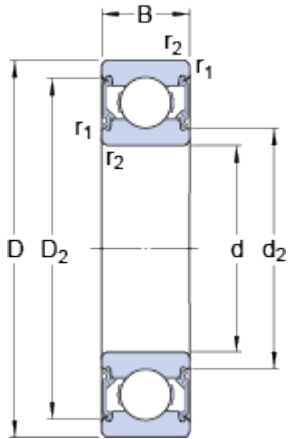

d		15	mm
D		35	mm
B		11	mm
d ₂	≈	18.6	mm
D ₂	≈	30.5	mm
r _{1,2}	min.	0.6	mm

Abutment dimensions

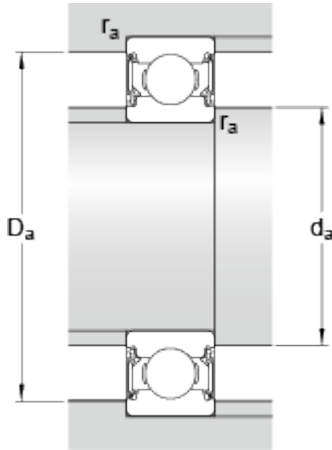

d _a	min.	19.2	mm
d _a	max.	19.4	mm
D _a	max.	31.3	mm
r _a	max.	0.6	mm

Calculation data

Basic dynamic load rating	C	8.06	kN
Basic static load rating	C	3.75	kN
Fatigue load limit	P _u	0.16	kN
Limiting speed		13000	r/min
Calculation factor	k _r	0.025	
Calculation factor	f	13	

Mass

Mass bearing		0.046	kg
--------------	--	-------	----