

6200-2RSH

SKF Explorer

Dimensions

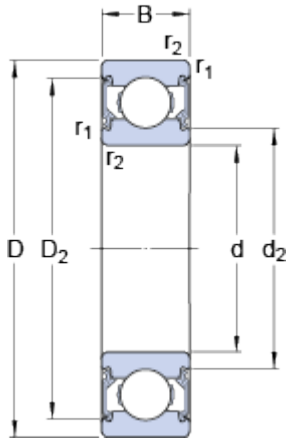

d		10	mm
D		30	mm
B		9	mm
d ₂	≈	15.07	mm
D ₂	≈	24.72	mm
r _{1,2}	min.	0.6	mm

Abutment dimensions

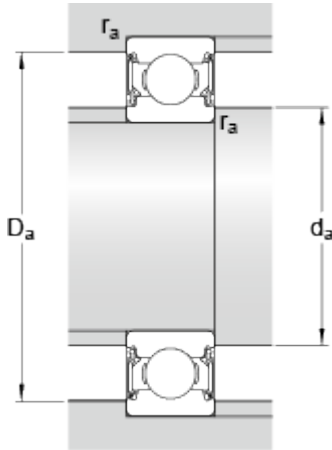

d _a	min.	14.2	mm
d _a	max.	15	mm
D _a	max.	25.8	mm
r _a	max.	0.6	mm

Calculation data

Basic dynamic load rating	C	5.4	kN
Basic static load rating	C	2.36	kN
Fatigue load limit	P _u	0.1	kN
Limiting speed		17000	r/min
Calculation factor	k _r	0.025	
Calculation factor	f	13	

Mass

Mass bearing		0.032	kg
--------------	--	-------	----