

61913

Dimensions

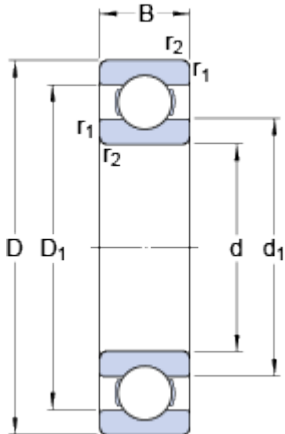

d		65	mm
D		90	mm
B		13	mm
d ₁	≈	73	mm
D ₁	≈	82.3	mm
r _{1,2}	min.	1	mm

Abutment dimensions

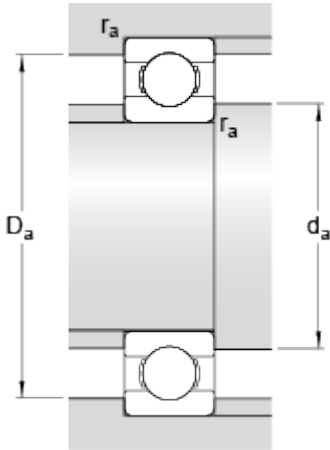

d _a	min.	69.6	mm
D _a	max.	85.4	mm
r _a	max.	1	mm

Calculation data

Basic dynamic load rating	C	17.4	kN
Basic static load rating	C	16	kN
Fatigue load limit	P _u	0.68	kN
Reference speed		15000	r/min
Limiting speed		9500	r/min
Calculation factor	k _r	0.02	
Calculation factor	f	16.6	

Mass

Mass bearing		0.22	kg
--------------	--	------	----