

61906-2RZ

Dimensions

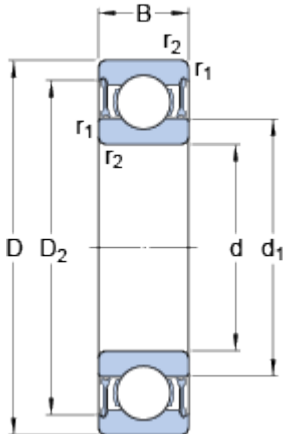

d		30	mm
D		47	mm
B		9	mm
d ₁	≈	35.25	mm
D ₂	≈	42.7	mm
r _{1,2}	min.	0.3	mm

Abutment dimensions

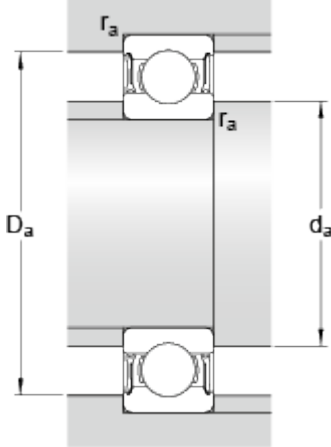

d _a	min.	32	mm
d _a	max.	35.1	mm
D _a	max.	45	mm
r _a	max.	0.3	mm

Calculation data

Basic dynamic load rating	C	7.28	kN
Basic static load rating	C	4.55	kN
Fatigue load limit	P _u	0.212	kN
Reference speed		30000	r/min
Limiting speed		15000	r/min
Calculation factor	k _r	0.02	
Calculation factor	f	14.4	

Mass

Mass bearing		0.051	kg
--------------	--	-------	----