

61903

Dimensions

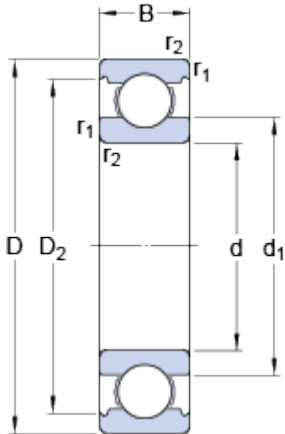

d		17	mm
D		30	mm
B		7	mm
d ₁	≈	20.4	mm
D ₂	≈	27.7	mm
r _{1,2}	min.	0.3	mm

Abutment dimensions

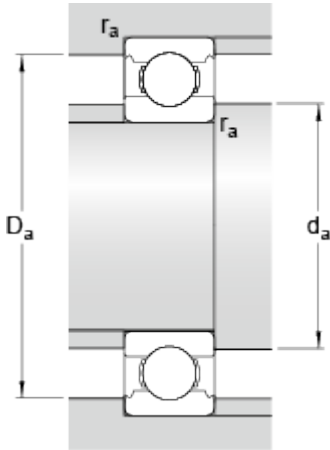

d _a	min.	19	mm
D _a	max.	28	mm
r _a	max.	0.3	mm

Calculation data

Basic dynamic load rating	C	4.62	kN
Basic static load rating	C	2.55	kN
Fatigue load limit	P _u	0.108	kN
Reference speed		50000	r/min
Limiting speed		32000	r/min
Calculation factor	k _r	0.02	
Calculation factor	f	14.7	

Mass

Mass bearing		0.016	kg
--------------	--	-------	----