

61902

Dimensions

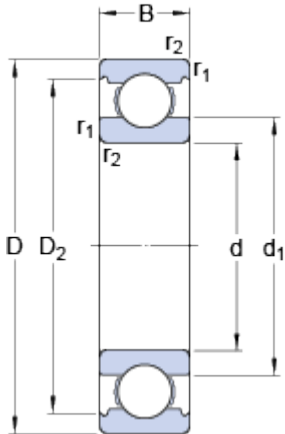

d		15	mm
D		28	mm
B		7	mm
d ₁	≈	18.8	mm
D ₂	≈	25.3	mm
r _{1,2}	min.	0.3	mm

Abutment dimensions

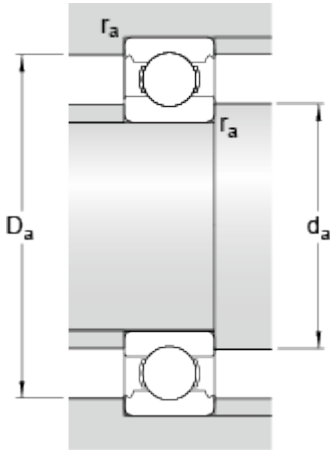

d _a	min.	17	mm
D _a	max.	26	mm
r _a	max.	0.3	mm

Calculation data

Basic dynamic load rating	C	4.36	kN
Basic static load rating	C	2.24	kN
Fatigue load limit	P _u	0.095	kN
Reference speed		56000	r/min
Limiting speed		34000	r/min
Calculation factor	k _r	0.02	
Calculation factor	f	14.3	

Mass

Mass bearing		0.016	kg
--------------	--	-------	----