

61810

Dimensions

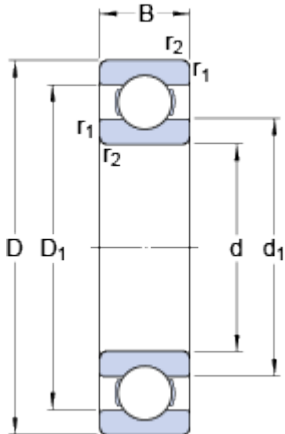

d		50	mm
D		65	mm
B		7	mm
d ₁	≈	54.67	mm
D ₁	≈	60.3	mm
r _{1,2}	min.	0.3	mm

Abutment dimensions

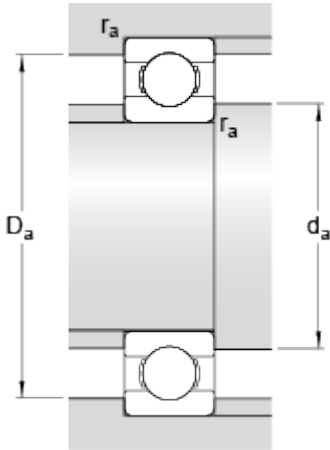

d _a	min.	52	mm
D _a	max.	63	mm
r _a	max.	0.3	mm

Calculation data

Basic dynamic load rating	C	6.76	kN
Basic static load rating	C	6.8	kN
Fatigue load limit	P _u	0.285	kN
Reference speed		20000	r/min
Limiting speed		13000	r/min
Calculation factor	k _r	0.015	
Calculation factor	f	17.2	

Mass

Mass bearing		0.052	kg
--------------	--	-------	----