

61801

Dimensions

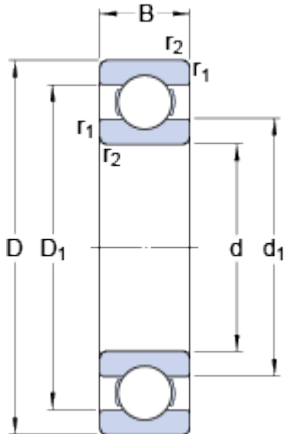

d		12	mm
D		21	mm
B		5	mm
d ₁	≈	14.8	mm
D ₁	≈	18.3	mm
r _{1,2}	min.	0.3	mm

Abutment dimensions

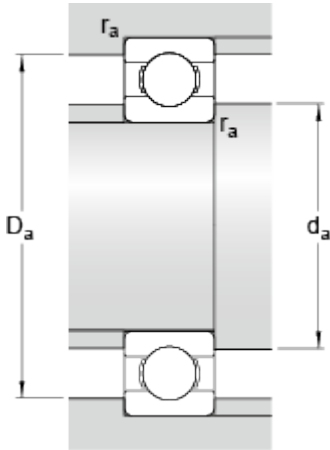

d _a	min.	14	mm
D _a	max.	19	mm
r _a	max.	0.3	mm

Calculation data

Basic dynamic load rating	C	1.74	kN
Basic static load rating	C	0.915	kN
Fatigue load limit	P _u	0.039	kN
Reference speed		70000	r/min
Limiting speed		43000	r/min
Calculation factor	k _r	0.015	
Calculation factor	f	13.4	

Mass

Mass bearing		0.0063	kg
--------------	--	--------	----