

609-2RSH

SKF Explorer

Dimensions

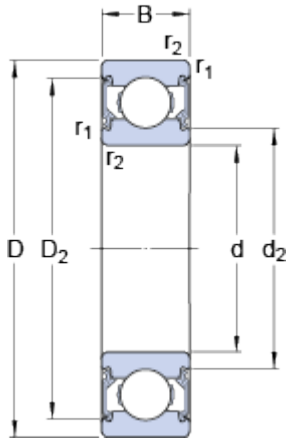

d		9	mm
D		24	mm
B		7	mm
d ₂	≈	12.85	mm
D ₂	≈	21.2	mm
r _{1,2}	min.	0.3	mm

Abutment dimensions

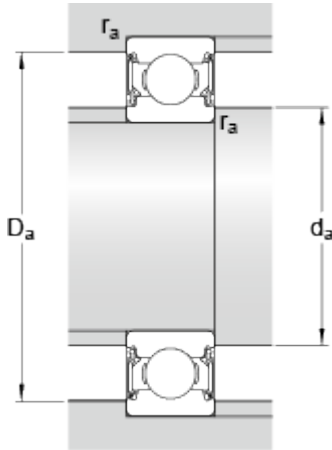

d _a	min.	11	mm
d _a	max.	12.5	mm
D _a	max.	22	mm
r _a	max.	0.3	mm

Calculation data

Basic dynamic load rating	C	3.9	kN
Basic static load rating	C	1.66	kN
Fatigue load limit	P _u	0.071	kN
Limiting speed		19000	r/min
Calculation factor	k _r	0.025	
Calculation factor	f	13	

Mass

Mass bearing		0.015	kg
--------------	--	-------	----