

6010-2Z

SKF Explorer

Dimensions



d		50	mm
D		80	mm
B		16	mm
d ₁	≈	59.75	mm
D ₂	≈	72.8	mm
r _{1,2}	min.	1	mm

Abutment dimensions

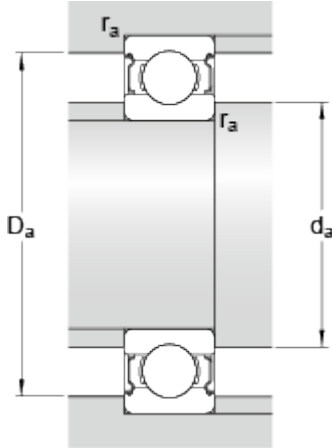

d _a	min.	54.6	mm
d _a	max.	59.7	mm
D _a	max.	75.4	mm
r _a	max.	1	mm

Calculation data

Basic dynamic load rating	C	22.9	kN
Basic static load rating	C	15.6	kN
Fatigue load limit	P _u	0.71	kN
Reference speed		18000	r/min
Limiting speed		9000	r/min
Calculation factor	k _r	0.025	
Calculation factor	f	14.7	

Mass

Mass bearing		0.27	kg
--------------	--	------	----