

52447

Dimensions

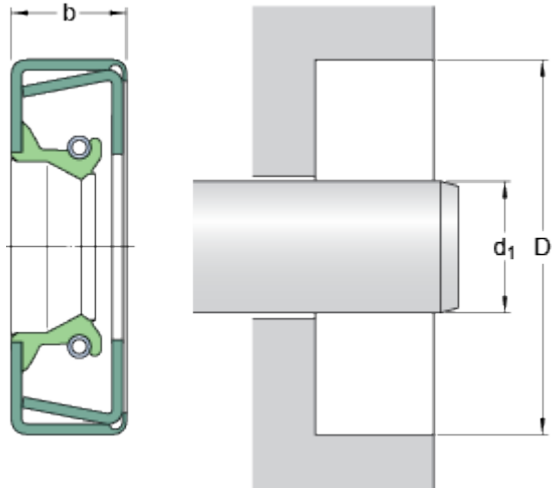

d_1	133.35	mm
D	158.75	mm
b	12.7	mm

Application and operating conditions

Pressure differential	max.	0.07	MPa
Operating temperature	min.	-40	°C
Operating temperature	max.	200	°C
Operating temperature, short period	max.	220	°C
Rotational speed	max.	2578	r/min
Shaft surface speed	max.	18	m/s