

# 51406

## Dimensions

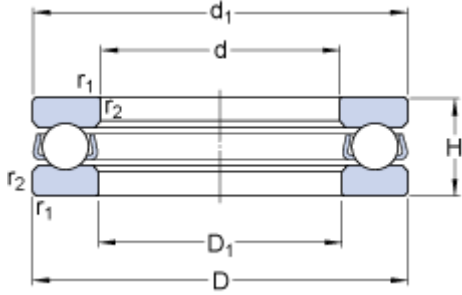

d		30	mm
D		70	mm
H		28	mm
d <sub>1</sub>	≈	70	mm
D <sub>1</sub>	≈	32	mm
r <sub>1,2</sub>	min.	1	mm

## Abutment dimensions

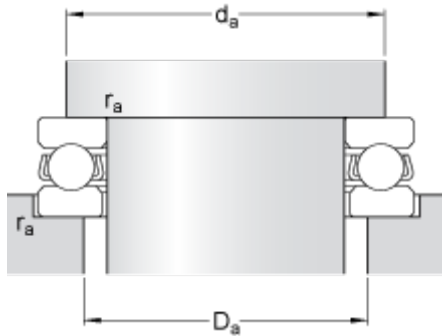

d <sub>a</sub>	min.	54	mm
D <sub>a</sub>	max.	46	mm
r <sub>a</sub>	max.	1	mm

## Calculation data

Basic dynamic load rating	C	70.2	kN
Basic static load rating	C	122	kN
Fatigue load limit	P <sub>u</sub>	4.5	kN
Reference speed		3000	r/min
Limiting speed		4300	r/min
Minimum load factor	A	0.097	

## Mass

Mass bearing (including seat washer where applicable)		0.52	kg
---	--	------	----