

51405

Dimensions

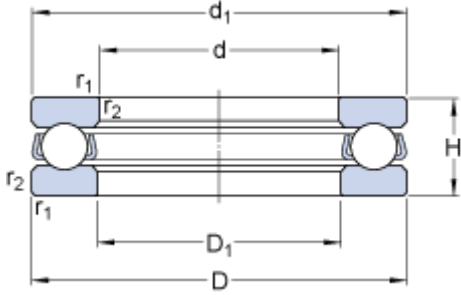

d	25	mm
D	60	mm
H	24	mm
d ₁	≈ 60	mm
D ₁	≈ 27	mm
r _{1,2}	min. 1	mm

Abutment dimensions

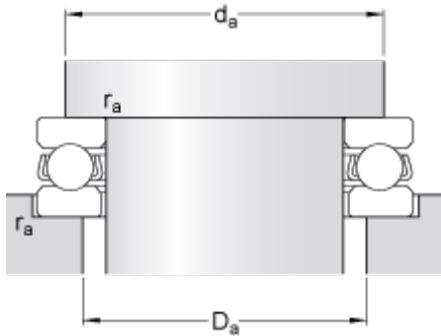

d _a	min. 46	mm
D _a	max. 39	mm
r _a	max. 1	mm

Calculation data

Basic dynamic load rating	C	42.3	kN
Basic static load rating	C	67	kN
Fatigue load limit	P _u	2.45	kN
Reference speed		3600	r/min
Limiting speed		5000	r/min
Minimum load factor	A	0.048	

Mass

Mass bearing (including seat washer where applicable)	0.34	kg
---	------	----