

51313

Dimensions

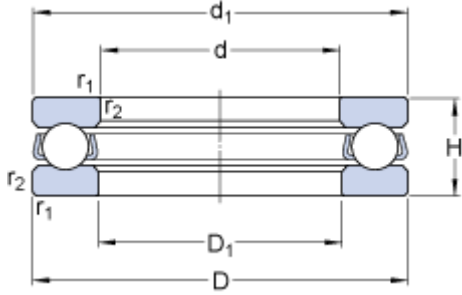

d	65	mm
D	115	mm
H	36	mm
d ₁	≈ 115	mm
D ₁	≈ 67	mm
r _{1,2}	min. 1.1	mm

Abutment dimensions

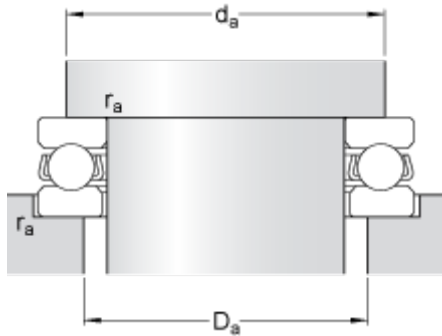

d _a	min. 95	mm
D _a	max. 85	mm
r _a	max. 1	mm

Calculation data

Basic dynamic load rating	C	106	kN
Basic static load rating	C	240	kN
Fatigue load limit	P _u	8.8	kN
Reference speed		2000	r/min
Limiting speed		3000	r/min
Minimum load factor	A	0.3	

Mass

Mass bearing (including seat washer where applicable)	1.5	kg
---	-----	----