

51305

Dimensions

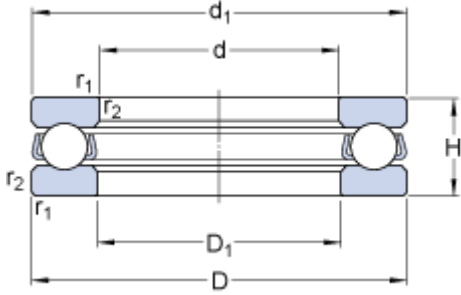

d		25	mm
D		52	mm
H		18	mm
d ₁	≈	52	mm
D ₁	≈	27	mm
r _{1,2}	min.	1	mm

Abutment dimensions

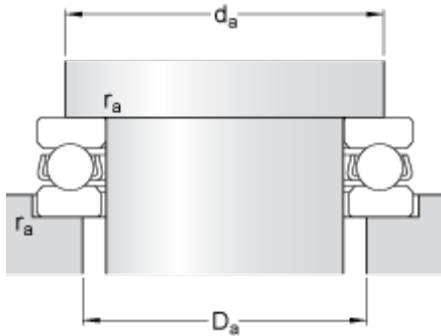

d _a	min.	41	mm
D _a	max.	36	mm
r _a	max.	1	mm

Calculation data

Basic dynamic load rating	C	34.5	kN
Basic static load rating	C	60	kN
Fatigue load limit	P _u	2.24	kN
Reference speed		4500	r/min
Limiting speed		6300	r/min
Minimum load factor	A	0.018	

Mass

Mass bearing (including seat washer where applicable)		0.17	kg
---	--	------	----