

51222

Dimensions

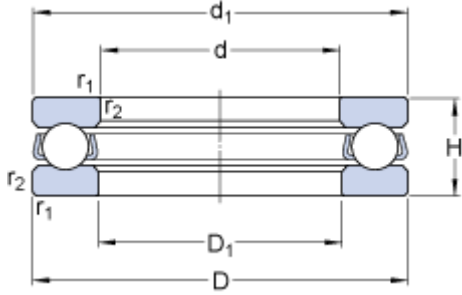

d		110	mm
D		160	mm
H		38	mm
d ₁	≈	160	mm
D ₁	≈	113	mm
r _{1,2}	min.	1.1	mm

Abutment dimensions

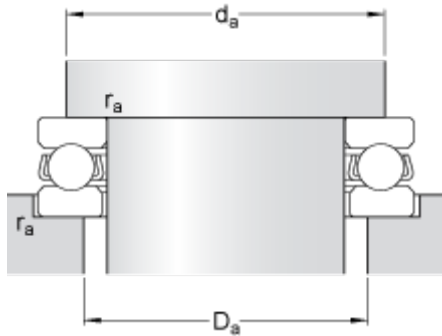

d _a	min.	140	mm
D _a	max.	130	mm
r _a	max.	1	mm

Calculation data

Basic dynamic load rating	C	125	kN
Basic static load rating	C	365	kN
Fatigue load limit	P _u	11.6	kN
Reference speed		1700	r/min
Limiting speed		2400	r/min
Minimum load factor	A	0.79	

Mass

Mass bearing (including seat washer where applicable)	2.4	kg
---	-----	----