

51213

Dimensions

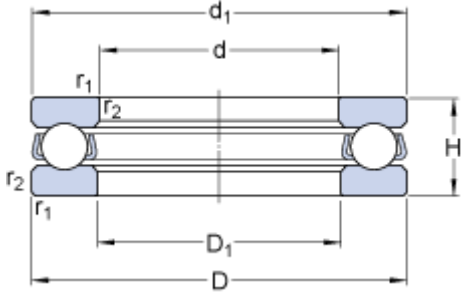

d	65	mm
D	100	mm
H	27	mm
d ₁	≈ 100	mm
D ₁	≈ 67	mm
r _{1,2}	min. 1	mm

Abutment dimensions

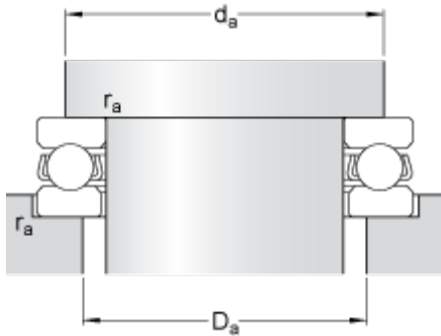

d _a	min. 86	mm
D _a	max. 79	mm
r _a	max. 1	mm

Calculation data

Basic dynamic load rating	C	60.5	kN
Basic static load rating	C	150	kN
Fatigue load limit	P _u	5.5	kN
Reference speed		2600	r/min
Limiting speed		3600	r/min
Minimum load factor	A	0.14	

Mass

Mass bearing (including seat washer where applicable)		0.72	kg
---	--	------	----