

# 51212

## Dimensions

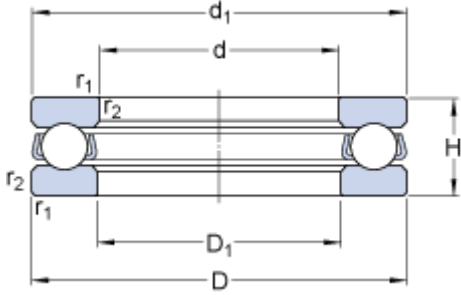

d		60	mm
D		95	mm
H		26	mm
d <sub>1</sub>	≈	95	mm
D <sub>1</sub>	≈	62	mm
r <sub>1,2</sub>	min.	1	mm

## Abutment dimensions

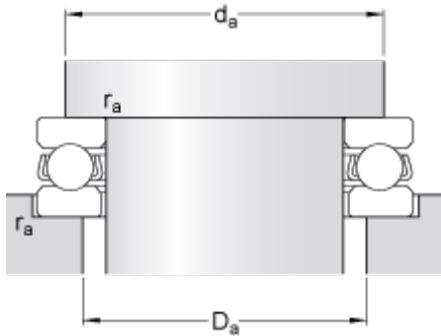

d <sub>a</sub>	min.	81	mm
D <sub>a</sub>	max.	74	mm
r <sub>a</sub>	max.	1	mm

## Calculation data

Basic dynamic load rating	C	59.2	kN
Basic static load rating	C	140	kN
Fatigue load limit	P <sub>u</sub>	5.1	kN
Reference speed		2800	r/min
Limiting speed		3800	r/min
Minimum load factor	A	0.12	

## Mass

Mass bearing (including seat washer where applicable)		0.65	kg
---	--	------	----