

51210

Dimensions

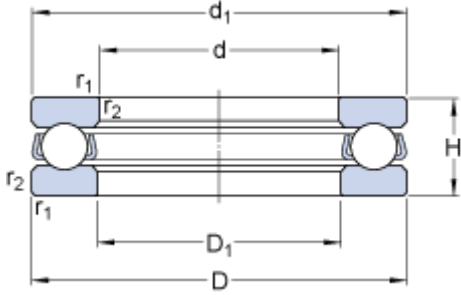

d		50	mm
D		78	mm
H		22	mm
d ₁	≈	78	mm
D ₁	≈	52	mm
r _{1,2}	min.	1	mm

Abutment dimensions

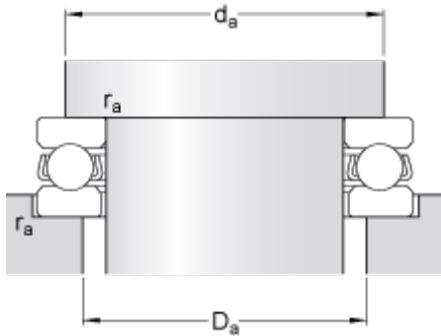

d _a	min.	67	mm
D _a	max.	61	mm
r _a	max.	1	mm

Calculation data

Basic dynamic load rating	C	49.4	kN
Basic static load rating	C	116	kN
Fatigue load limit	P _u	4.3	kN
Reference speed		3400	r/min
Limiting speed		4500	r/min
Minimum load factor	A	0.069	

Mass

Mass bearing (including seat washer where applicable)		0.37	kg
---	--	------	----