

51207

Dimensions

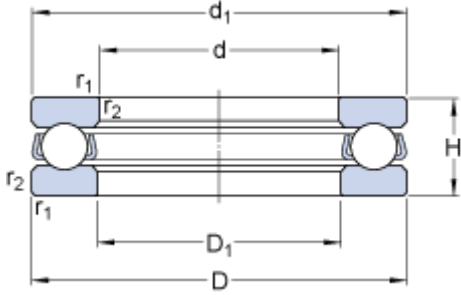

d		35	mm
D		62	mm
H		18	mm
d ₁	≈	62	mm
D ₁	≈	37	mm
r _{1,2}	min.	1	mm

Abutment dimensions

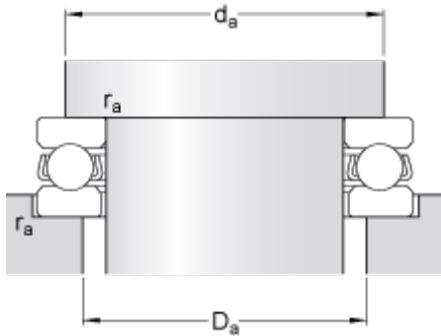

d _a	min.	51	mm
D _a	max.	46	mm
r _a	max.	1	mm

Calculation data

Basic dynamic load rating	C	35.1	kN
Basic static load rating	C	73.5	kN
Fatigue load limit	P _u	2.7	kN
Reference speed		4000	r/min
Limiting speed		5600	r/min
Minimum load factor	A	0.028	

Mass

Mass bearing (including seat washer where applicable)		0.22	kg
---	--	------	----