

# 51204

## Dimensions

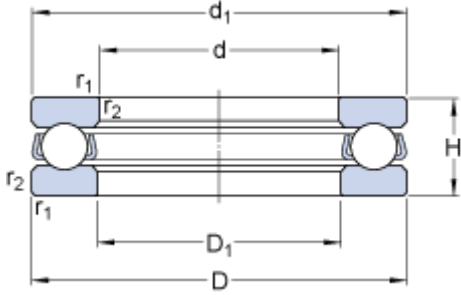

d	20	mm
D	40	mm
H	14	mm
d <sub>1</sub>	≈ 40	mm
D <sub>1</sub>	≈ 22	mm
r <sub>1,2</sub>	min. 0.6	mm

## Abutment dimensions

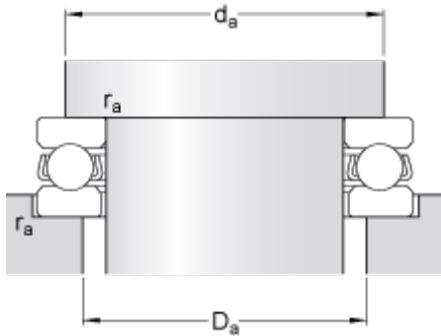

d <sub>a</sub>	min. 32	mm
D <sub>a</sub>	max. 28	mm
r <sub>a</sub>	max. 0.6	mm

## Calculation data

Basic dynamic load rating	C	21.2	kN
Basic static load rating	C	37.5	kN
Fatigue load limit	P <sub>u</sub>	1.4	kN
Reference speed		6000	r/min
Limiting speed		8000	r/min
Minimum load factor	A	0.0085	

## Mass

Mass bearing (including seat washer where applicable)		0.083	kg
---	--	-------	----