

51122

Dimensions

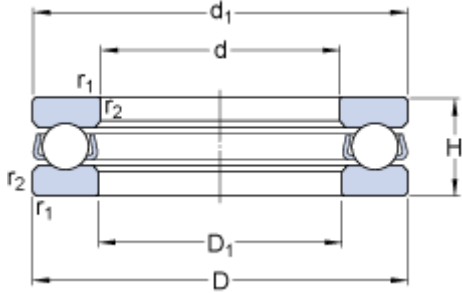

d		110	mm
D		145	mm
H		25	mm
d ₁	≈	145	mm
D ₁	≈	112	mm
r _{1,2}	min.	1	mm

Abutment dimensions

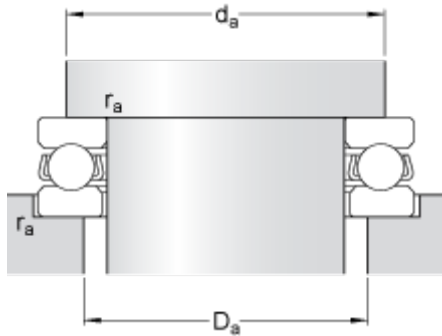

d _a	min.	131	mm
D _a	max.	124	mm
r _a	max.	1	mm

Calculation data

Basic dynamic load rating	C	83.2	kN
Basic static load rating	C	285	kN
Fatigue load limit	P _u	9.5	kN
Reference speed		2200	r/min
Limiting speed		3200	r/min
Minimum load factor	A	0.52	

Mass

Mass bearing (including seat washer where applicable)		1.05	kg
---	--	------	----