

51118

Dimensions

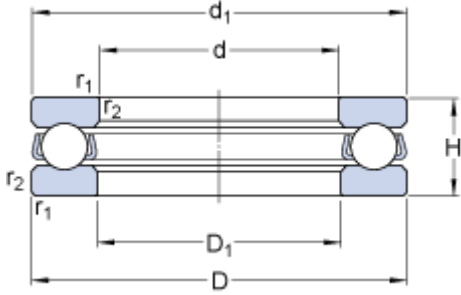

d		90	mm
D		120	mm
H		22	mm
d ₁	≈	120	mm
D ₁	≈	92	mm
r _{1,2}	min.	1	mm

Abutment dimensions

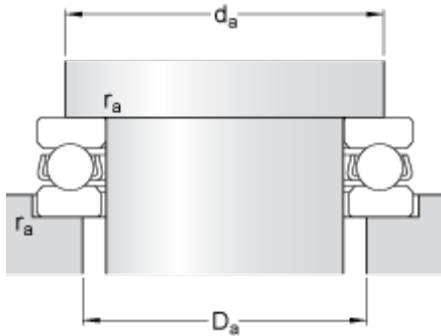

d _a	min.	108	mm
D _a	max.	102	mm
r _a	max.	1	mm

Calculation data

Basic dynamic load rating	C	59.2	kN
Basic static load rating	C	208	kN
Fatigue load limit	P _u	7.5	kN
Reference speed		2600	r/min
Limiting speed		3800	r/min
Minimum load factor	A	0.22	

Mass

Mass bearing (including seat washer where applicable)		0.67	kg
---	--	------	----