

51112

Dimensions

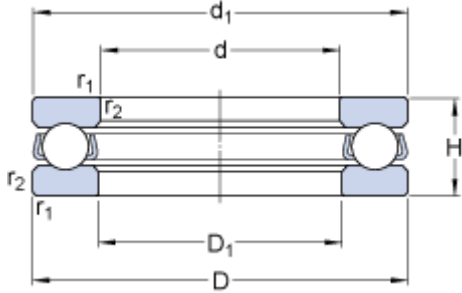

d		60	mm
D		85	mm
H		17	mm
d ₁	≈	85	mm
D ₁	≈	62	mm
r _{1,2}	min.	1	mm

Abutment dimensions

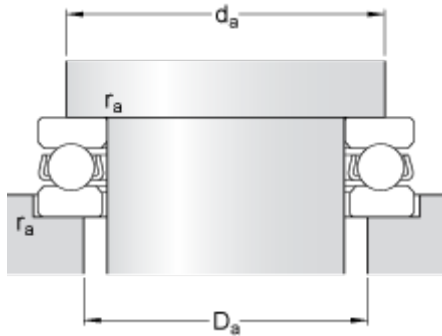

d _a	min.	75	mm
D _a	max.	70	mm
r _a	max.	1	mm

Calculation data

Basic dynamic load rating	C	41.6	kN
Basic static load rating	C	122	kN
Fatigue load limit	P _u	4.55	kN
Reference speed		3600	r/min
Limiting speed		5000	r/min
Minimum load factor	A	0.077	

Mass

Mass bearing (including seat washer where applicable)		0.27	kg
---	--	------	----