

# 51109

## Dimensions

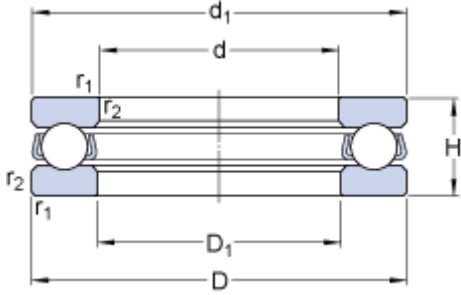

d		45	mm
D		65	mm
H		14	mm
d <sub>1</sub>	≈	65	mm
D <sub>1</sub>	≈	47	mm
r <sub>1,2</sub>	min.	0.6	mm

## Abutment dimensions

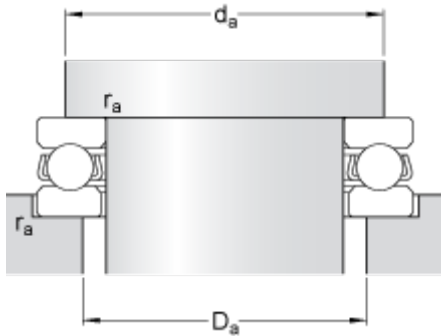

d <sub>a</sub>	min.	57	mm
D <sub>a</sub>	max.	53	mm
r <sub>a</sub>	max.	0.6	mm

## Calculation data

Basic dynamic load rating	C	26.5	kN
Basic static load rating	C	69.5	kN
Fatigue load limit	P <sub>u</sub>	2.55	kN
Reference speed		4500	r/min
Limiting speed		6300	r/min
Minimum load factor	A	0.025	

## Mass

Mass bearing (including seat washer where applicable)		0.14	kg
---	--	------	----