

49929

Dimensions

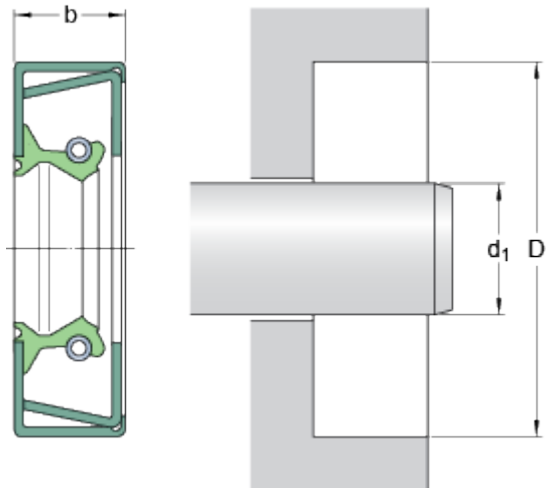

d_1	127	mm
D	152.43	mm
b	12.7	mm

Application and operating conditions

Pressure differential	max.	0.07	MPa
Operating temperature	min.	-40	°C
Operating temperature	max.	100	°C
Operating temperature, short period	max.	120	°C
Rotational speed	max.	2707	r/min
Shaft surface speed	max.	18	m/s