

4213 ATN9

Dimensions

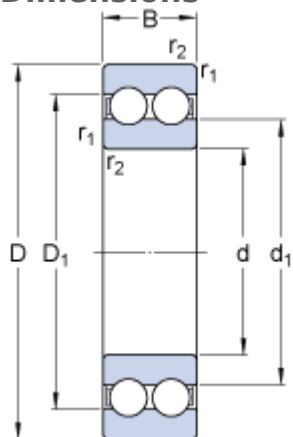

d		65	mm
D		120	mm
B		31	mm
d ₁	≈	82.9	mm
D ₁	≈	99.1	mm
r _{1,2}	min.	1.5	mm

Abutment dimensions

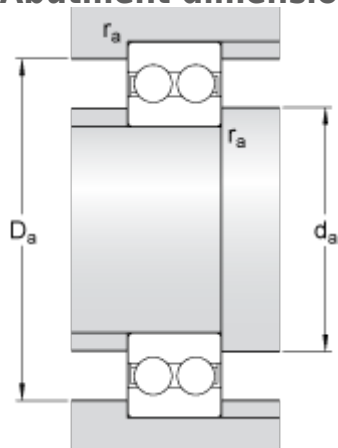

d _a	min.	74	mm
D _a	max.	111	mm
r _a	max.	1.5	mm

Calculation data

Basic dynamic load rating	C	67.6	kN
Basic static load rating	C	67	kN
Fatigue load limit	P _u	2.8	kN
Reference speed		8500	r/min
Limiting speed		4800	r/min
Calculation factor	k _r	0.05	
Calculation factor	f	15	

Mass

Mass bearing		1.45	kg
--------------	--	------	----