

41x53x7 CRW1 R

Dimensions

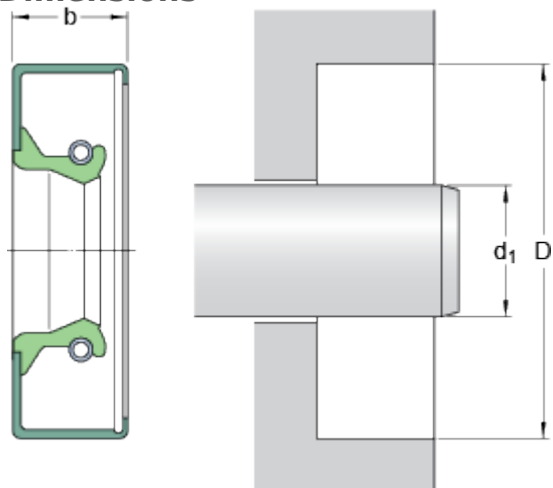

d_1	41	mm
D	53	mm
b	7	mm

Application and operating conditions

Pressure differential	max.	0.07	MPa
Operating temperature	min.	-40	°C
Operating temperature	max.	100	°C
Operating temperature, short period	max.	120	°C
Rotational speed	max.	8385	r/min
Shaft surface speed	max.	18	m/s