

402202

Dimensions

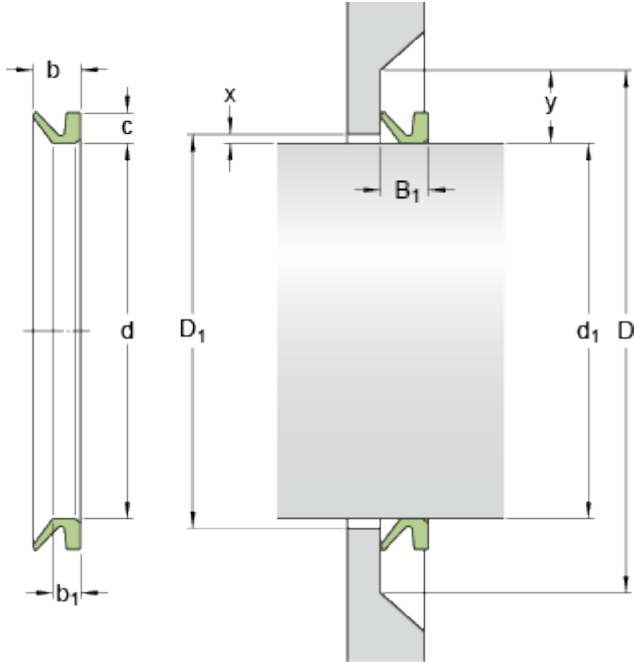

Shaft diameter range

d_1	over	210	mm
d_1	incl.	233	mm

Seal and abutment

d		198	mm
b_1		6	mm
b		10.5	mm
c		6.5	mm
$2x$		5	mm
$D_1 \text{ max.} = d_1 + 2X$			
$2y$		20	mm
$D \text{ min.} = d_1 + 2Y$			
B_1		8	mm
	\pm	1.5	mm