

# 38669

## Dimensions

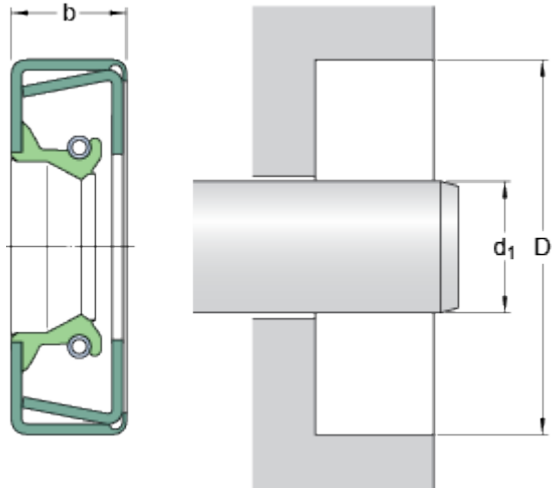

$d_1$	98.425	mm
D	123.85	mm
b	12.7	mm

## Application and operating conditions

Pressure differential	max.	0.07	MPa
Operating temperature	min.	-40	°C
Operating temperature	max.	100	°C
Operating temperature, short period	max.	120	°C
Rotational speed	max.	3493	r/min
Shaft surface speed	max.	18	m/s