

32396

Dimensions

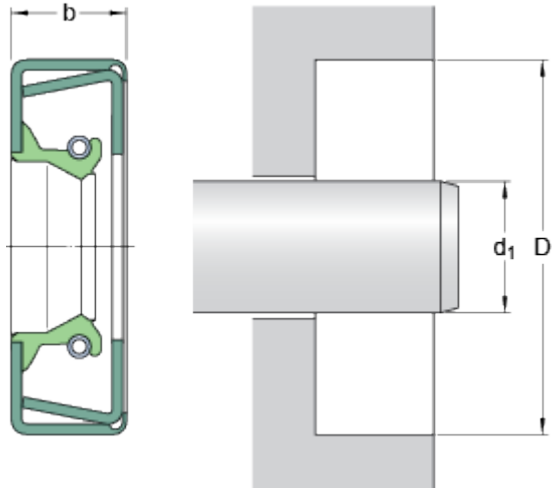

| | | |
|-------|--------|----|
| d_1 | 82.55 | mm |
| D | 107.92 | mm |
| b | 11.13 | mm |

Application and operating conditions

| | | | |
|-------------------------------------|------|------|-------|
| Pressure differential | max. | 0.07 | MPa |
| Operating temperature | min. | -40 | °C |
| Operating temperature | max. | 100 | °C |
| Operating temperature, short period | max. | 120 | °C |
| Rotational speed | max. | 4164 | r/min |
| Shaft surface speed | max. | 18 | m/s |