

28474

Dimensions

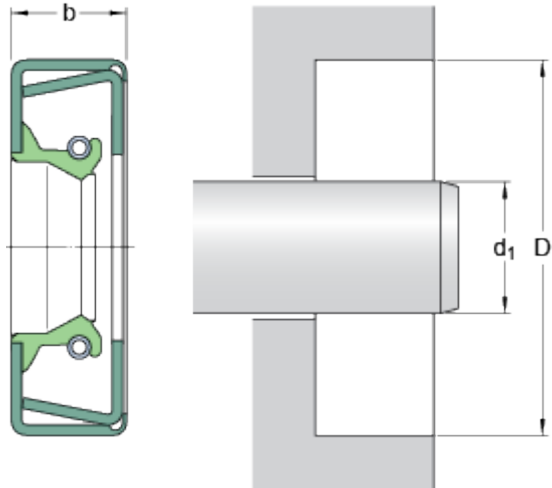

d_1	72.238	mm
D	101.68	mm
b	12.7	mm

Application and operating conditions

Pressure differential	max.	0.07	MPa
Operating temperature	min.	-40	°C
Operating temperature	max.	200	°C
Operating temperature, short period	max.	220	°C
Rotational speed	max.	4759	r/min
Shaft surface speed	max.	18	m/s