

# 26298

## Dimensions

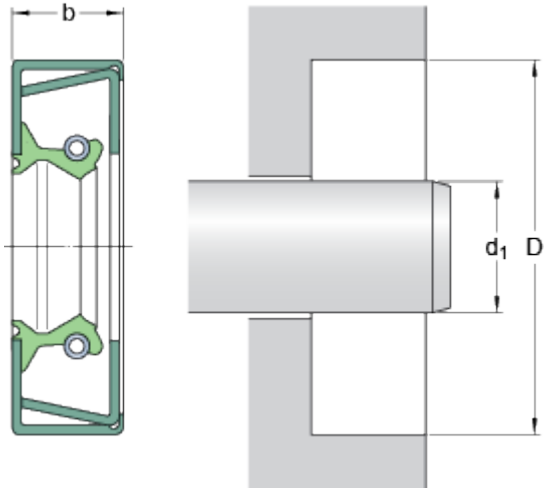

$d_1$	66.675	mm
D	95.28	mm
b	11.13	mm

## Application and operating conditions

Pressure differential	max.	0.07	MPa
Operating temperature	min.	-40	°C
Operating temperature	max.	100	°C
Operating temperature, short period	max.	120	°C
Rotational speed	max.	5156	r/min
Shaft surface speed	max.	18	m/s