

23779

Dimensions

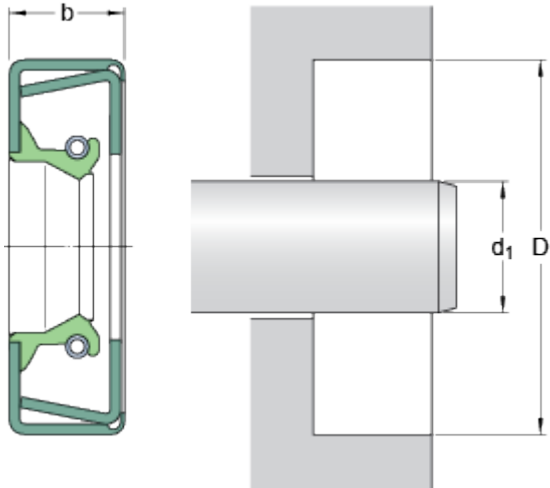

d_1	60.325	mm
D	88.9	mm
b	9.53	mm

Application and operating conditions

Pressure differential	max.	0.07	MPa
Operating temperature	min.	-40	°C
Operating temperature	max.	100	°C
Operating temperature, short period	max.	120	°C
Rotational speed	max.	5699	r/min
Shaft surface speed	max.	18	m/s