

2303 E-2RS1TN9

Dimensions

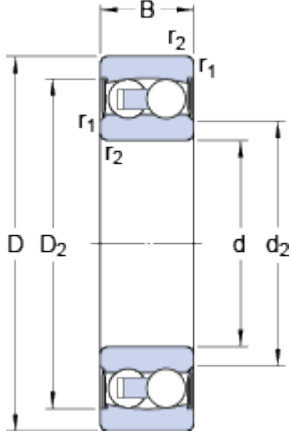

d		17	mm
D		47	mm
B		19	mm
d ₂	≈	25.5	mm
D ₂	≈	41.23	mm
r _{1,2}	min.	1	mm

Abutment dimensions

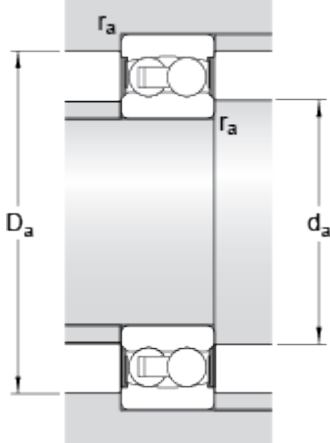

d _a	min.	22	mm
d _a	max.	25.5	mm
D _a	max.	41.4	mm
r _a	max.	1	mm

Calculation data

Basic dynamic load rating	C	12.7	kN
Basic static load rating	C	3.4	kN
Fatigue load limit	P _u	0.18	kN
Limiting speed		11000	r/min
Permissible angular misalignment	α	1.5	°
Calculation factor	k _r	0.05	
Calculation factor	e	0.3	
Calculation factor	Y	2.2	
Calculation factor	Y ₁	2.1	
Calculation factor	Y ₂	3.3	

Mass

Mass bearing		0.16	kg
--------------	--	------	----