

22211 E

SKF Explorer

Dimensions

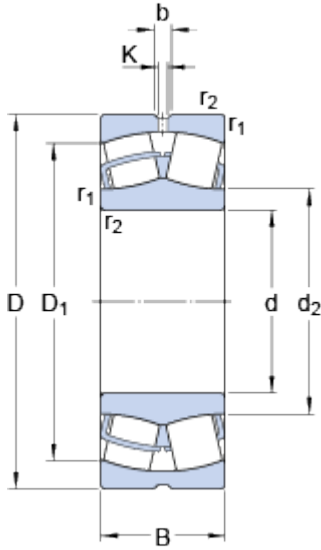

d		55	mm
D		100	mm
B		25	mm
d ₂	≈	65.3	mm
D ₁	≈	88	mm
b		6	mm
K		3	mm
r _{1,2}	min.	1.5	mm

Abutment dimensions

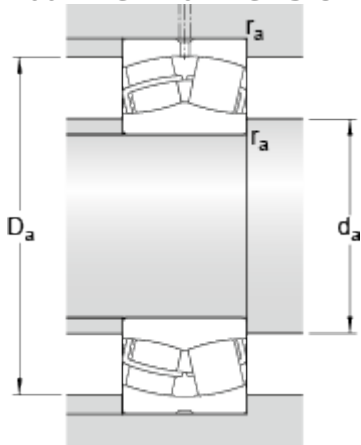

d _a	min.	64	mm
D _a	max.	91	mm
r _a	max.	1.5	mm

Calculation data

Basic dynamic load rating	C	129	kN
Basic static load rating	C	127	kN
Fatigue load limit	P _u	13.7	kN
Reference speed		6300	r/min
Limiting speed		8500	r/min
Calculation factor	e	0.24	
Calculation factor	Y ₁	2.8	
Calculation factor	Y ₂	4.2	
Calculation factor	Y	2.8	

Mass

Mass bearing		0.84	kg
--------------	--	------	----

